

STIEBEL ELTRON

High Quality
WATER FILTER
by Stiebel Eltron / Germany

USER MANUAL | STREAM (3 STAGE) WATER FILTER



STREAM

USER MANUAL STREAM (3 STAGE). STREAM FEATURES.

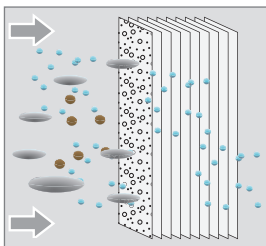

Ultrafiltration membrane

The ultrafiltration membrane removes bacteria and provides microbiological safe and clean drinking water for you and your family.

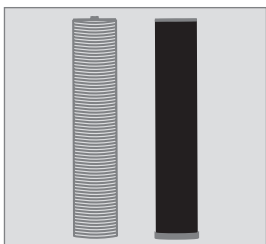

Sediment (1 micron) and carbon block (0.5 micron)

The sediment and carbon block filters with a very small pore size take out small particles down to 0.5 micron.

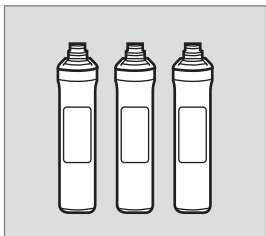

Encapsulated filter

Encapsulated filters allow a clean and safe filtration process without contamination from the outside. The high quality filter media allow for an extraordinary clean and safe filter performance.

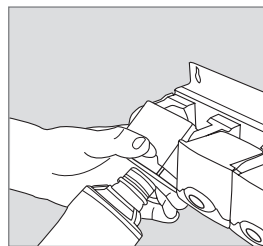

Filter replacement

The Stiebel Eltron stream filter cartridges are easy to change. The PUSH & CLICK system allows the filter change without using any tool. No plumber or expert is needed.

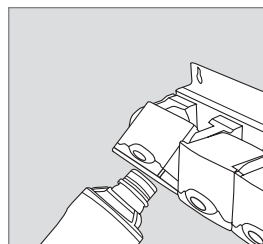

Automatic water shut off

The filter system has an integrated automatic water stop. As soon as the filter is plugged out of the adapter the water flow will shut off automatically.

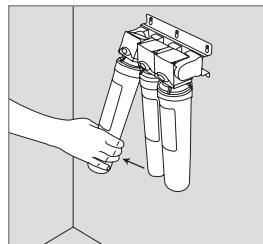

Clip function - space saving

Because of the clip function of the filter system there is no extra space needed for under the sink installation. The filter can be easily changed.

USER MANUAL STREAM (3 STAGE).

CONTENT.

1. Stream filter components	04
2. Faucet and accessories	05
3. Operating instructions	06
4. Filter specifications	07
5. Installation and precautions	08
6. Installation guidelines	09-10
7. Filter replacement	11
8. Trouble shooting	12

USER MANUAL STREAM (3 STAGE).

1. STREAM FILTER COMPONENTS.

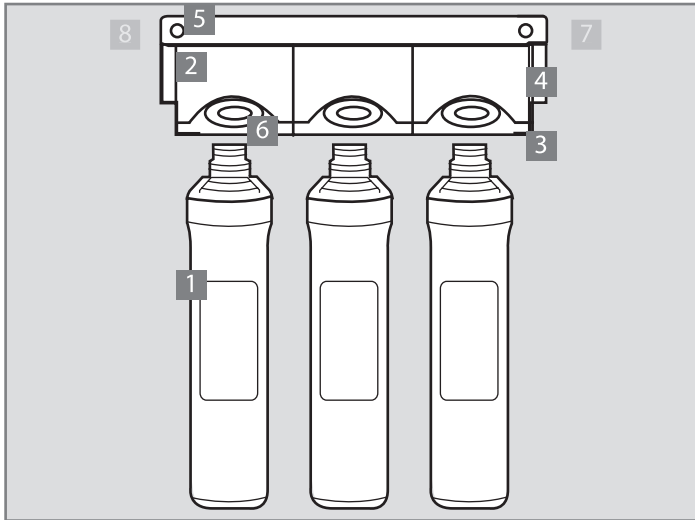

- 1 Encapsulated filter
- 2 Filter adapter
- 3 Lower adapter part
- 4 Upper adapter part
- 5 Holes for wall-mount installation
- 6 Push button for filter change
- 7 Quick connector for water outlet
- 8 Quick connector for water inlet

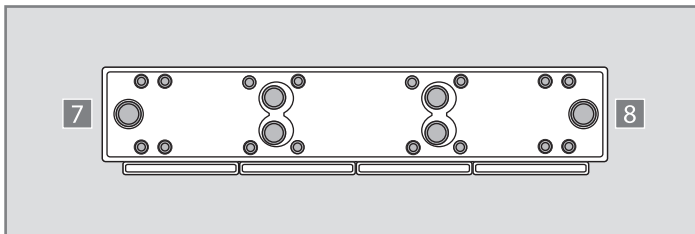

USER MANUAL STREAM (3 STAGE).

2. FAUCET AND ACCESSORIES.

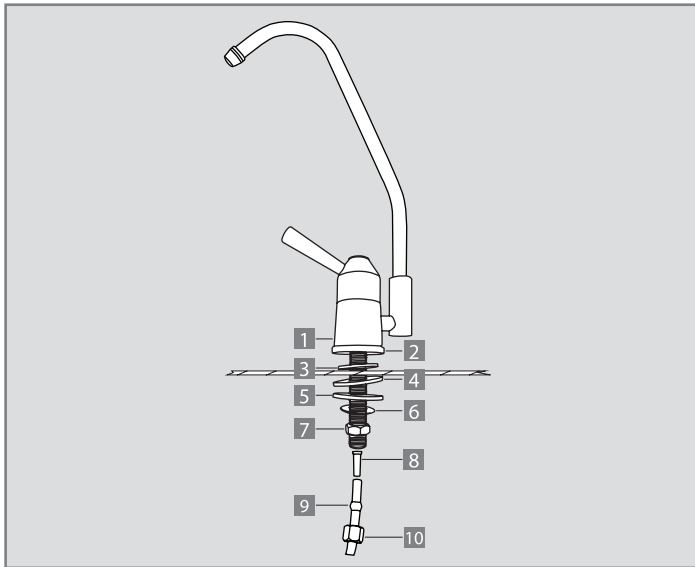

- 1 Faucet
- 2 Plate
- 3 Rubber washer
- 4 Washer
- 5 Plastic washer
- 6 Inner tooth washer
- 7 Double-ended nut
- 8 Plastic plug
- 9 Plastic hollow ball
- 10 Locking nut
- 11 Plastic tube [1 x 1.5 m]
- 12 Manual
- 13 Diverter ball valve
- 14 Nipple
- 15 „L” connector

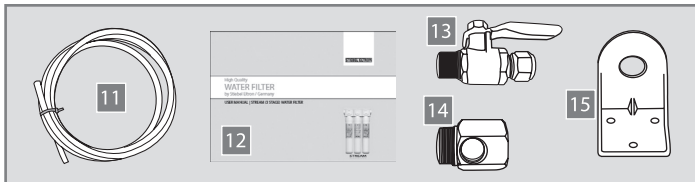

USER MANUAL STREAM (3 STAGE).

3. OPERATING INSTRUCTIONS.

Type name		Stream 3 stage (10") Part no. 1611-222306	Stream 3 stage (13") Part no. 1611-222307
Installation type		under sink, wall-mounted	under sink, wall-mounted
Filter type		encapsulated	encapsulated
Max. operating pressure		4 bar	4 bar
Min. operating pressure		1 bar	1 bar
Max. operating temperature		35 °C	35 °C
Min. operating temperature		4 °C	4 °C
Max. operating flow		4 L / min	4 L / min
Sediment filter	material	polypropylene	polypropylene
	micron rating	1 micron	1 micron
	rated life time	2160 L or 6 months*	2880 L or 8 months*
Pre-carbon	material	activated carbon	activated carbon
	micron rating	0.5 micron	0.5 micron
	rated life time	2160 L or 6 months*	2880 L or 8 months*
Ultrafiltration membrane	material	hollow fiber polysulfone	hollow fiber polysulfone
	micron rating	0.01~0.3 micron	0.01~0.3 micron
	rated life time	3600 L or 10 months*	4320 L or 12 months*

USER MANUAL STREAM (3 STAGE).

4. FILTER SPECIFICATIONS.

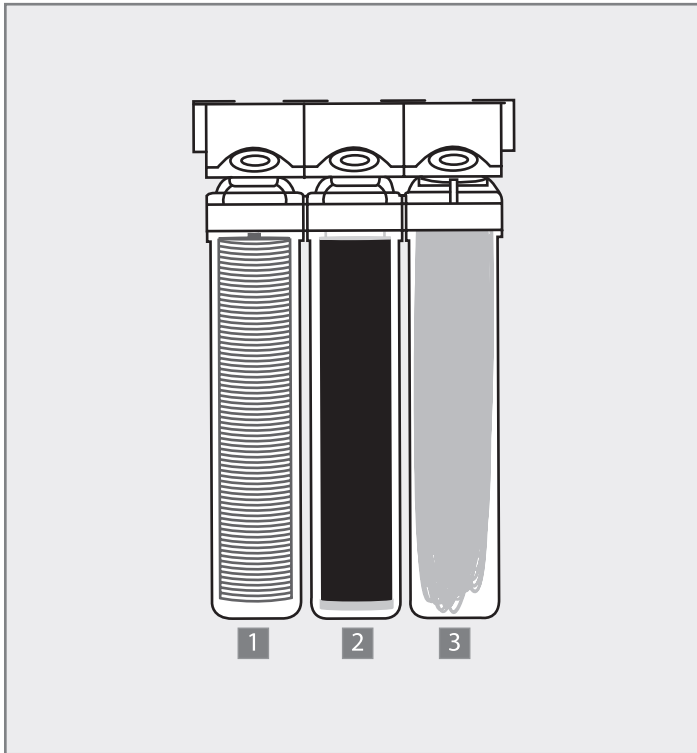

Filter step	Removal function
1. Polypropylene sediment filter 1 micron	rust and sediments
2. Activated carbon block filter 0.5 micron	bad taste and odor
	chlorine
	THMs
	VOCs
3. Ultrafiltration membrane 0.01-0.3 micron	bacteria
	cysts

USER MANUAL STREAM (3 STAGE).

5. INSTALLATION AND PRECAUTIONS.

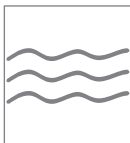

The water filter can only be used with pre-filtered water from a water supply facility. The filter cannot be used with water from unsafe water sources such as rivers and wells.



To reach an optimized and satisfying filter result the water filter should only be installed in houses with a pipe pressure between 1 and 4 bar.



The water filter must be installed in a far distance to inflammable materials and heating sources to avoid deformation.



The water filter should only be installed inside the house.

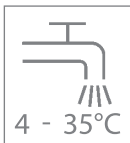

The filter can only be installed to the cold water supply with a water temperature between 4 and 35°C.



Replace the filters according to the schedule to insure clean drinking water.



The water filter should not be exposed to force or shock.



The water filter must be kept away or protected from direct light (e.g. sunlight).

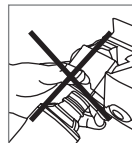

Never use the PUSH button for filter replacement during water flow. The equipment may break down due to high pressure. For filter exchange close the diverter valve.

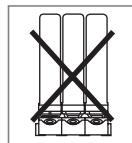

Please install the filter upright. In case of moving or raising the filter make sure that the filter stays upright.

USER MANUAL STREAM (3 STAGE).

6. INSTALLATION GUIDELINES.

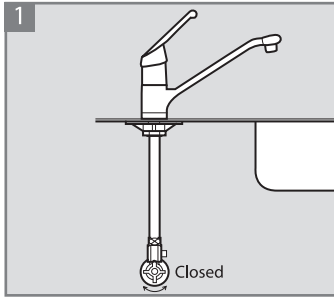

1 Lock the stop valve of the cold water supply line.

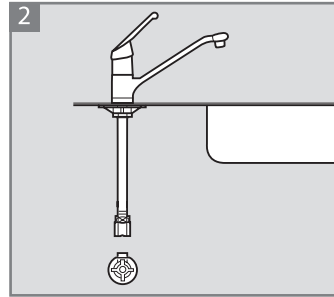

2 Detach the metal hose from the cold water supply under the sink.

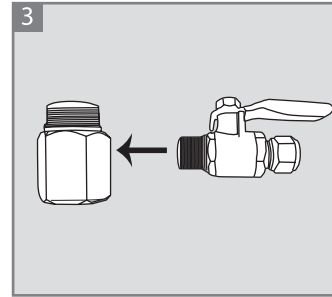

3 Connect the diverter ball valve with the nipple (use teflon-tape).

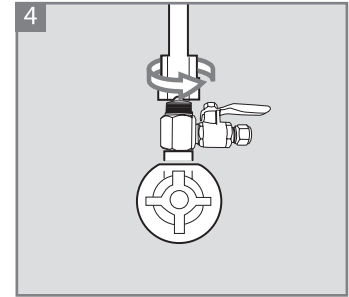

4 Assemble the ball valve and nipple to the water supply. Re-attach the metal hose.

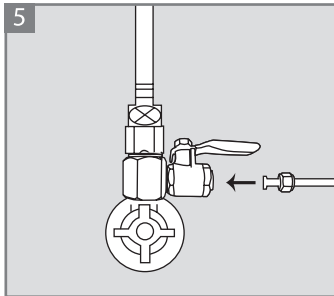

5 Cut the plastic tube in 2 pieces. Connect the inlet tube and tighten the tube with the cap.

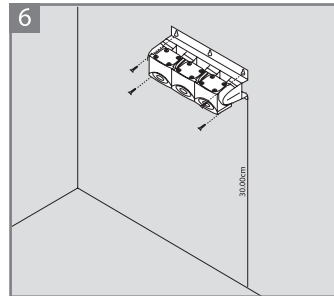

6 Select a proper place under the sink that has at least 25 cm (10") / 30 cm (13") from the floor to allow to insert the cartridges easily. Make holes into the wall to fix the filter adapter under the sink.

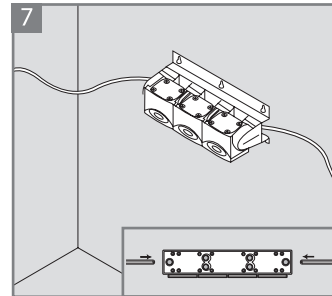

7 Insert the plastic tube and connect the adapter on the wall.

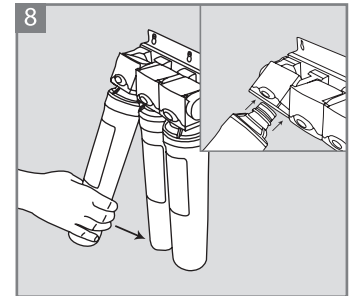

8 Bring the adapter in upward position and insert the filter. A loud "click" will signal that the filter is attached properly. Bring the filter back in the normal position.

USER MANUAL STREAM (3 STAGE).

6. INSTALLATION GUIDELINES.

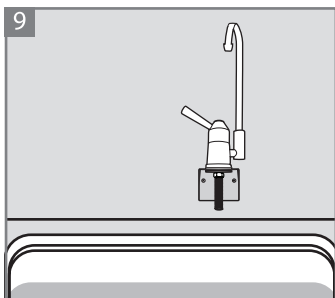

In case of wall-mounted installation of the faucet use the „L“ connector to fix the faucet similar to the descriptions in picture 11-12.

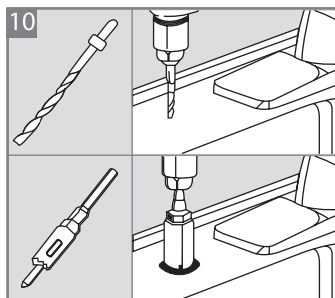

Select a proper place for the faucet. Drill a placement hole into the sink.

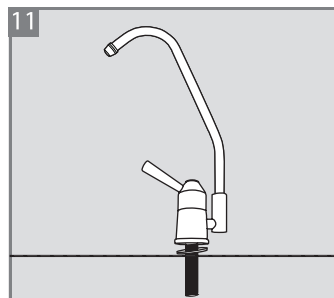

Insert the base washer to the screw beneath the faucet's main body and insert the faucet to the hole.

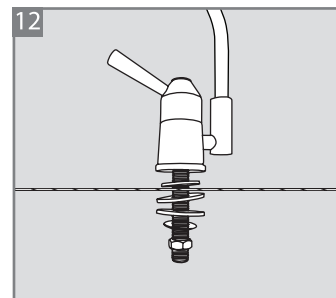

Insert the rubber washer from beneath the sink and fix the faucet in place.

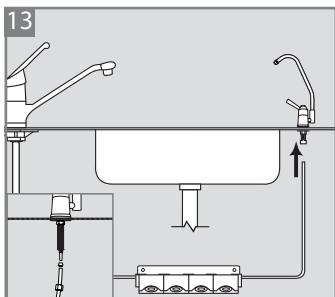

Connect the outlet tube with the drinking water faucet connector.

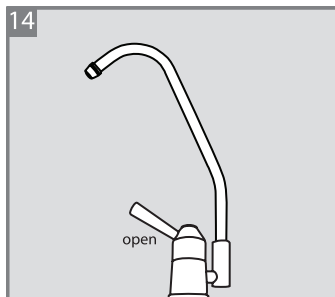

Before operating the system open the faucet.

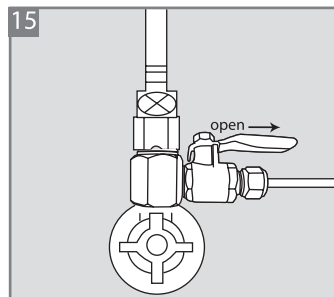

Open the diverter valve under the sink slowly. Check the whole system for water leakages.

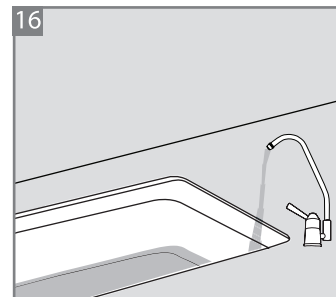

If there is no installation mistake or leakage keep the faucet open for 10 minutes to bring rest particles and air out of the unit.

USER MANUAL STREAM (3 STAGE).

7. FILTER REPLACEMENT.

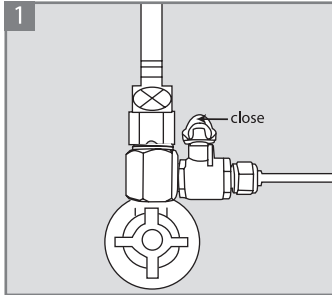

1 Close the diverter valve under the sink.

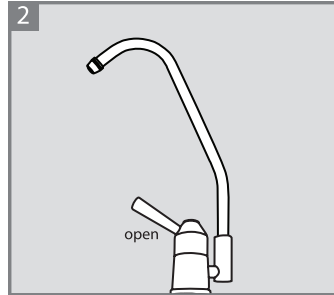

2 Open the faucet shortly to release the pressure in the system.

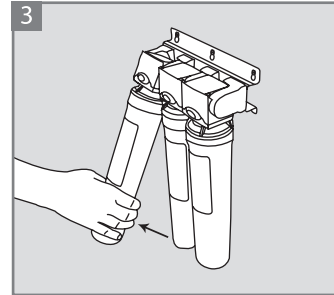

3 Pull the adapter connector to an angle of 45° while holding the filter.

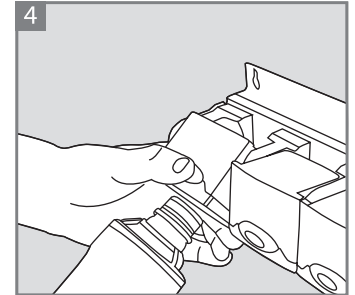

4 Press the push button and rotate the filter to eject.

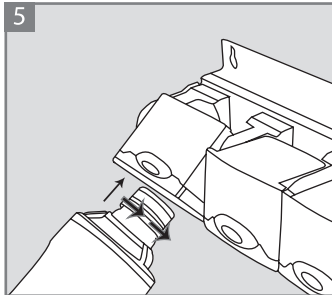

5 Remove the cap of the new filter and insert in the head connector. A "click" will signal that the filter cartridge is connected properly.

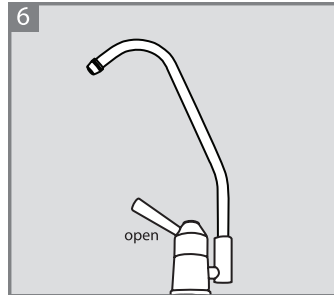

6 Before operating the system open the faucet.

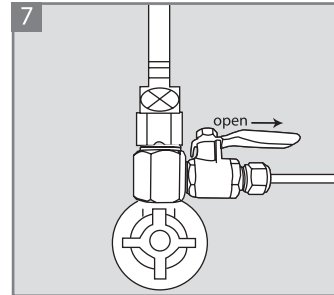

7 Open the diverter valve under the sink slowly. Check the whole system for water leakages.

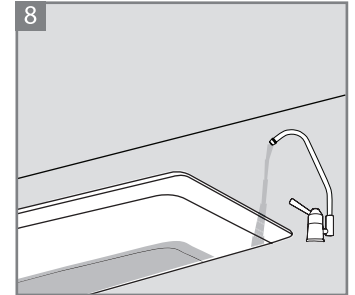

8 If there is no installation mistake or leakage keep the faucet open for 10 minutes to bring residual particles and air out of the unit.

USER MANUAL STREAM (3 STAGE).

8. TROUBLE SHOOTING.

Problems	Possible cause	Trouble shooting
Black color or black particles in the water.	The stream water filter contains carbon powder. After installation small particles can occur in the water.	After installation or filter exchange let the water flow for about 10 minutes to clean the filter from possible small residual particles of carbon.
Slow water flow.	The lifetime of the filter is finished.	Replace the filter cartridge.
	The filter is clogged.	Replace the filter cartridge.
Noise in the system.	There are air bubbles in the system.	After installation let the water flow for about 10 minutes to remove all air from the system.
Unusual water or chlorine taste/bad odor.	The cartridge does not remove chlorine and other contaminants from the water. The life time of the filter cartridge is finished.	Replace the filter cartridge.
	You have not used the filter for a while and some sediments and contaminants developed a bad smell in the system.	Open the valves and let the water flow for at least 5 minutes.
Water leakage.	Tubes, fittings, nipples might not be connected properly.	Check every connection to be inserted in the proper depth.
No water flow.	The diverter valve is closed.	Open the diverter valve.

GERMANY

STIEBEL ELTRON INTERNATIONAL GMBH | DR.-STIEBEL-STRASSE | 37603 HOLZMINDEN
PHONE +49 5531 7020 | E-MAIL INFO@STIEBEL-ELTRON.COM | WWW.STIEBEL-ELTRON.COM

STIEBEL ELTRON